



Aufgaben

Bilde Malaufgaben!

1. 

• 5 =

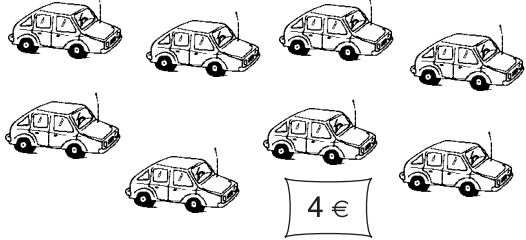
2. 

• € = €

3. 

• Cent = Cent

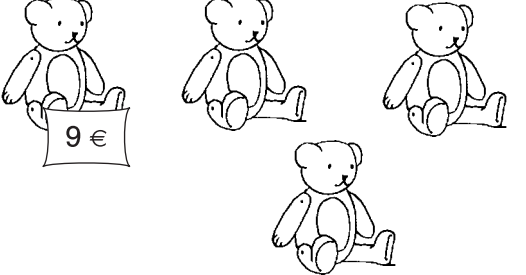
4. 

• € = €

5. 

• =

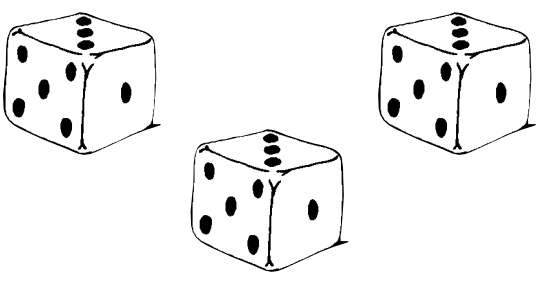
6. 

• =

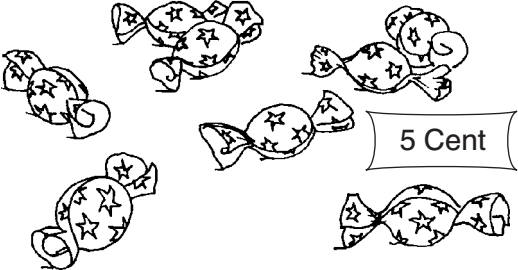
7. 

• Cent = Cent

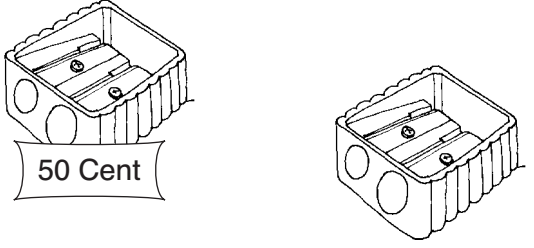
8. 

• Cent = Euro



Aufgaben

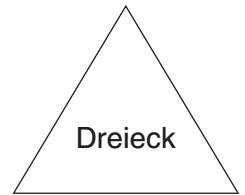
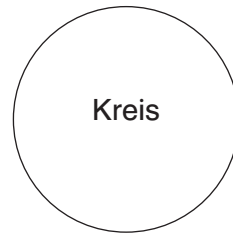
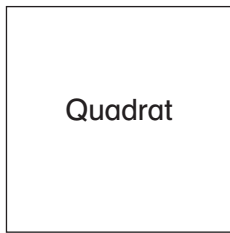

1. Male Quadrate grün, Rechtecke blau, Kreise gelb und Dreiecke rot an.

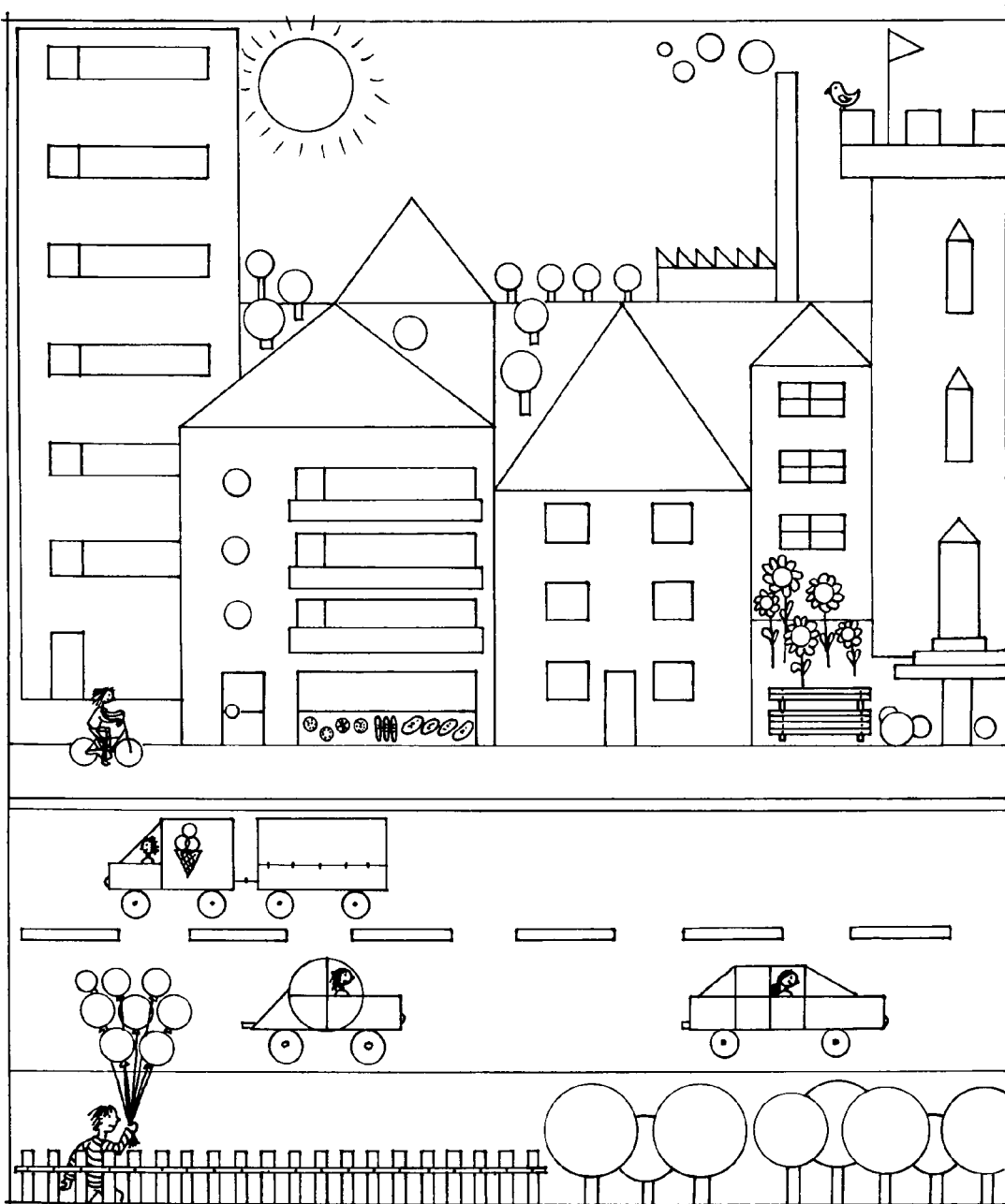

2. Wie viele Figuren hast du gefunden? Schreibe die Anzahl auf.

Quadrate: _____ Rechtecke: _____ Kreise: _____ Dreiecke: _____

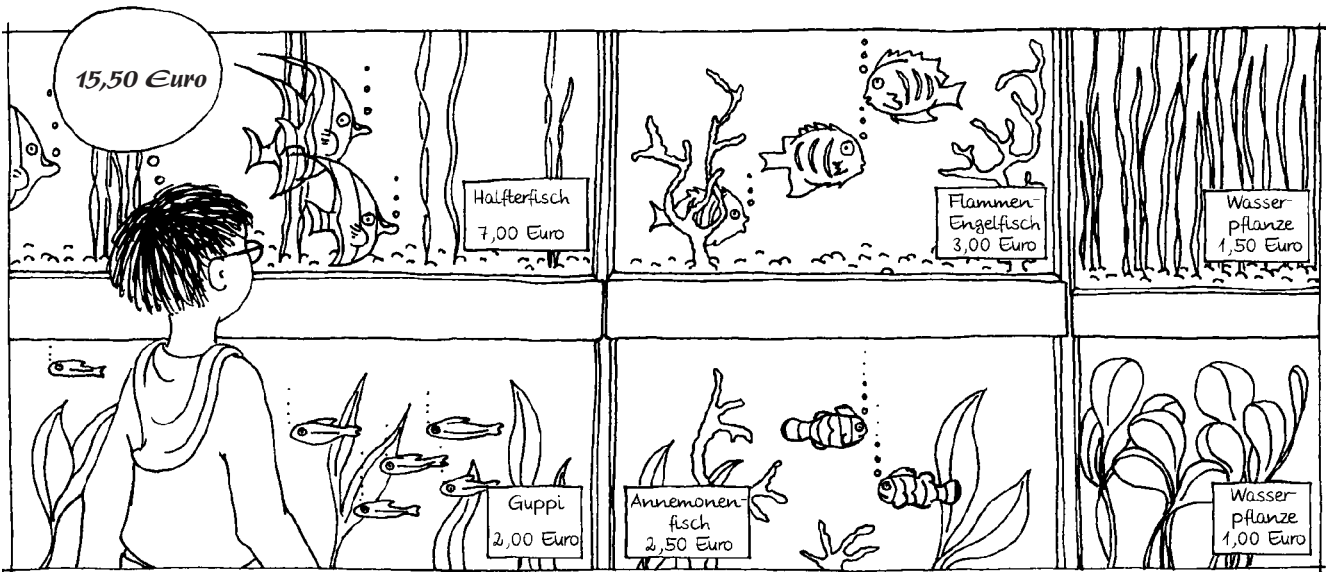

Aufgaben

1. Wie viel Geld hat Max dabei? _____ Euro
2. Max möchte einen Halbterfisch kaufen. Wie viel Euro kostet er? _____ Euro
3. Max möchte außerdem noch zwei Annemonefische kaufen. Diese kosten _____ Euro.

4. Rechne aus, wie viel Geld Max jetzt noch übrig hat?

_____ Euro

5. Sein Vater schenkt ihm noch 2 Euro. Wie viele Wasserpflanzen kann er noch mitnehmen?

_____ Wasserpflanzen
